

3M

Headset Intercom System

Model C1060

Operating Instructions

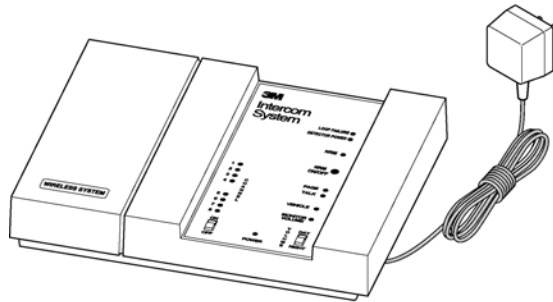

Base Station



Headset

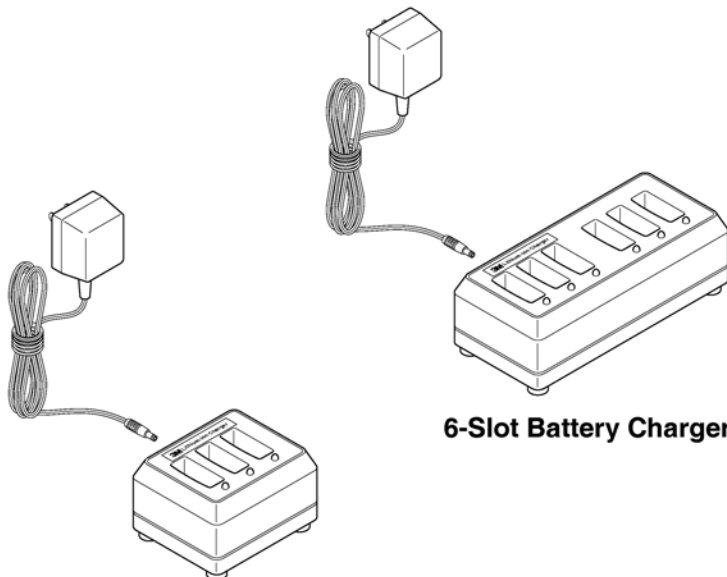

6-Slot Battery Charger

3-Slot Battery Charger

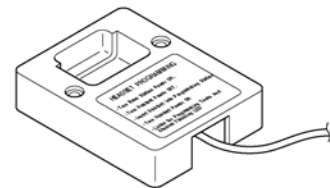

Programming Station

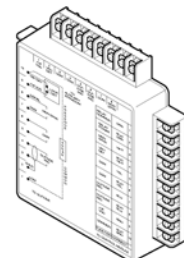

Interconnect Module

Safety Information iii
 Intended Useiii

FCC Information..... iv

System Description..... 1
 Introduction.....1
 System Configurations.....1
 Single-Lane Standard Communication System1
 Single-Lane Duplex Communication System.....1
 Dual-Lane Standard Communication System.....1
 Dual-Lane Duplex Communication System1
 Cross-Lane Communication System1
 System Components.....2
 Base Station.....2
 Headset2
 Programming Station.....3
 Battery Charger3

Controls and Indicator..... 4
 Base Station4
 Headset.....5
 Battery Chargers7

Headset Preparation..... 8
 Adjusting Headband Size8
 Positioning the Ear Pad and Microphone8

Operation 9
 System Startup9
 Turning On the Base Station9
 Turning On the Headset.....9
 Operating Modes.....9
 Standby Mode.....9
 Talk/Listen Mode9
 Single-Lane Standard or Duplex Communication Systems9
 Dual-Lane Standard or Duplex Communication Systems.....9
 Cross-Lane Communication Systems9

Talk Lock Mode (“Hands Free”) 10

Page Mode..... 11

Page Monitor Mode 11

Special Considerations 12

Maintenance..... 13

Headset 13

 Replacing the Battery 13

 Replacing the Ear and Headband Pads..... 14

Battery Charger..... 15

 Location 15

 Cleaning the Contacts 15

Batteries 15

 Care, Handling, and Storage 15

 Low Battery Tone 15

 Charging Batteries..... 15

 Disposing of Batteries 16

 Making Sure Batteries are Ready for Use..... 16

 Important Information about C1060 Rechargeable Batteries 16

Special Instructions for System Manager 17

 Programming the Headset for Cross-Lane Operation 17

 Reprogramming 17

 Enabling/Disabling the Talk Lock Feature..... 18

 Changing Channels if Interference is Encountered 18

 Changing the Day/Night Switch Setting..... 21

 Adjusting the Monitor Speaker Volume..... 22

Troubleshooting..... 23

 Introduction 23

 System Troubleshooting 23

 Battery and Battery Charger Troubleshooting 26

 Service 26

SAFETY INFORMATION



Safety Rules for C1060 Installation Instructions & C1060 Operating Instructions



Read, understand, and follow all safety information contained in these instructions prior to installation & operation of the 3M Headset Intercom System, Model C1060. Failure to follow all instructions listed could result in electrical shock, fire and/or other personal injury. Retain these instructions for future reference.

Intended Use:

The 3M Headset Intercom System Model C1060 is intended for use to provide 2-way radio-frequency audio communication in quick service drive-through restaurants and convenience stores.

The system must be installed as specified in the Model C1060 Installation Instructions and operated as specified in Model C1060 Operating Instructions in quick service drive-through restaurants and convenience stores. It has not been evaluated for other uses or locations.

EXPLANATION OF SIGNAL WORD CONSEQUENCES	
 WARNING:	Indicates a potentially hazardous situation, which, if not avoided, could result in death or serious injury and/or property damage.
 CAUTION:	Indicates a potentially hazardous situation, which, if not avoided, may result in minor or moderate injury and/or property damage.
CAUTION:	Indicates a potentially hazardous situation, which, if not avoided, may result in property damage.

EXPLANATION OF PRODUCT SAFETY LABEL SYMBOLS	
	Attention: Read accompanying documentation
	Warning: Risk of Electric Shock

✓ IMPORTANT NOTES

Important notes are used in the C1060 Installation Instructions and C1060 Operating Instructions to denote system function or performance information.

 **WARNING****To reduce the risks associated with hazardous voltage:**

- Disconnect power to the receptacle before installing or removing the Base Station Power Supply. When removing receptacle cover screw, cover may fall across plug pins or receptacle may become displaced. Use only with duplex receptacle having center screw. Secure unit in place by receptacle cover screw.
- If power supply is supplied with a grounding pin, connect directly to a grounding receptacle - 3 prong.
- Use inside in a dry location only.

To reduce the risks associated fire & property damage:

- Do not open, crush, expose to heat above 200 F or incinerate the battery.
- Always replace batteries, battery chargers and power supplies with 3M approved units acceptable for use in this system to avoid system function & safety concerns.

 **CAUTION****To reduce the risks associated with environmental contamination due to battery pack & to lead in the solder:**

- Dispose of batteries, power supplies, battery charger and base station in accordance with federal, state & local requirements. If preferred, return these components to 3M Service Center for disposal.

IMPORTANT INFORMATION

- Clean battery, battery charger & headset contacts with a water moistened cotton swab.
- Recommend turning the headset off then back on (which automatically sets the volume to mid level) then adjust volume to preferred level prior to each user change.
- For communications equipment sales and service, contact your local 3M authorized intercom dealer. If special service assistance is needed, or for information on how to properly dispose of your non-functional C1060 rechargeable batteries, please call **(800) 328-0033**. For more information, visit the 3M Foodservice Web site: <http://www.3m.com/foodservice>

FCC INFORMATION

This device complies with part 15 of the FCC Rules listed ID HCQ3B63MH3, Canada 2309104369A and Australia & New Zealand AS4268.2.1995 & AS3548.1995.A2.1997. Operation is subject to the following two conditions: (1) This device may not cause harmful interference, and (2) this device must accept any interference received, including interference that may cause undesired operation. These limits are designed to provide a reasonable protection against harmful interference when the equipment is operated in a commercial environment. This equipment generates, and can radiate radio frequency energy and, if not installed and used in accordance with the instruction manuals, may cause harmful interference to radio communications. Changes or modifications not expressly approved by the party responsible for compliance could void the user's authority to operate the equipment.

Introduction

The 3M Model C1060 Headset Intercom System is a wireless intercom system designed for high reliability, compactness, and ease of service.

The system can be programmed to operate on any one of 16 different channels to provide high-quality audio performance and reduce the possibility of interference between neighboring wireless systems.

System Configurations

The system can be configured in one of five ways depending on the number of menu signs (lanes) at the facility and the type of communication desired.

Single-Lane Standard Communication System

The *single-lane standard communication system* provides standard communication (talk *or* listen) for facilities that have one menu sign.

The system consists of one base station and one or more headsets and battery chargers.

Single-Lane Duplex Communication System

The *single-lane duplex communication system* provides duplex communication (simultaneous talk and listen) for facilities that have one menu sign.

The system consists of one base station and one or more headsets and battery chargers.

Dual-Lane Standard Communication System

The *dual-lane standard communication system* provides standard communication (talk *or* listen) for facilities that have two menu signs.

The system consists of two independent systems - one dedicated to menu sign 1 and the other dedicated to menu sign 2. The headsets are programmed to work with one system or the other and are labeled accordingly (1 or 2).

Dual-Lane Duplex Communication System

The *dual-lane duplex communication system* provides duplex communication (simultaneous talk *and* listen) for facilities that have two menu signs.

The system consists of two independent systems - one dedicated to menu sign 1 and the other dedicated to menu sign 2. The headsets are programmed to work with one system or the other and are labeled accordingly (1 or 2).

Cross-Lane Communication System

The *cross-lane communication system* provides duplex communication (simultaneous talk *and* listen) for facilities that have two menu signs.

The system consists of two duplex systems that are connected to a cross-lane module. The headsets are programmed for either lane 1 or lane 2.

During *off-peak* hours, the cross-lane module can be turned ON to link the two systems and enable one operator to simultaneously talk *and* listen to customers at menu sign 1 or menu sign 2 or with other headset operators.

During *peak* hours, the cross-lane module can be turned OFF to separate the systems and enable menu sign 1 operators to talk to customers at menu sign 1, and menu sign 2 operators to talk to customers at menu sign 2.

Systems Components

The number of system components and the procedures necessary to operate them vary depending on the system configuration. However, four components are common to all system configurations.

Base Station

The base station is the interface between the customer at the menu sign and the headset worn by the operator. See Figure 1.

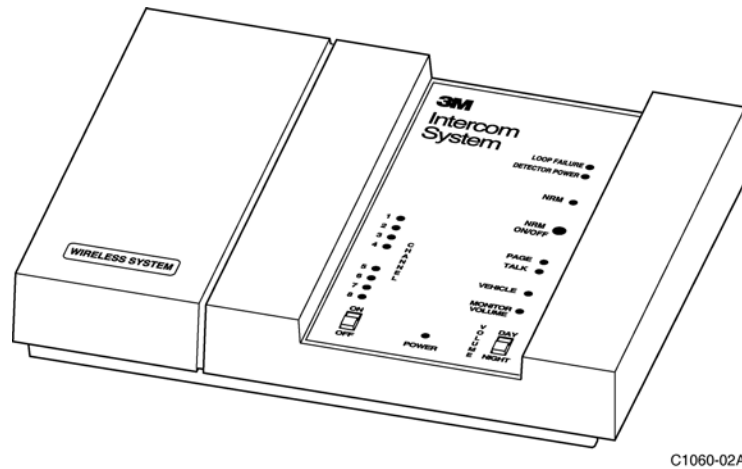

Figure 1. Base Station

Headset

The headset is a wireless, battery-powered, two-way radio used by the operator to communicate with menu sign customers and with other store personnel who are wearing headsets.

Headsets feature a light-weight design to provide for comfort. The headset pads can be easily replaced. See Figure 2.



Figure 2. Headset

The programming station is used to program C960 and C1060 headsets to the same channel as the base station. Infrared light is used to transfer program data to the C1060 headset and a separate jack is provided for the C960 headset programming cable. See Figure 3.

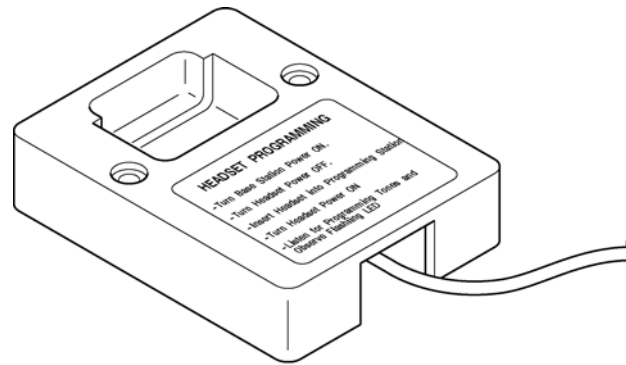

C1060-04A

Figure 3. Programming Station

Battery Charger

The battery charger charges headset batteries in approximately 1.5 to 2 hours. The charger is available in 3-slot and 6-slot versions. See Figure 4.

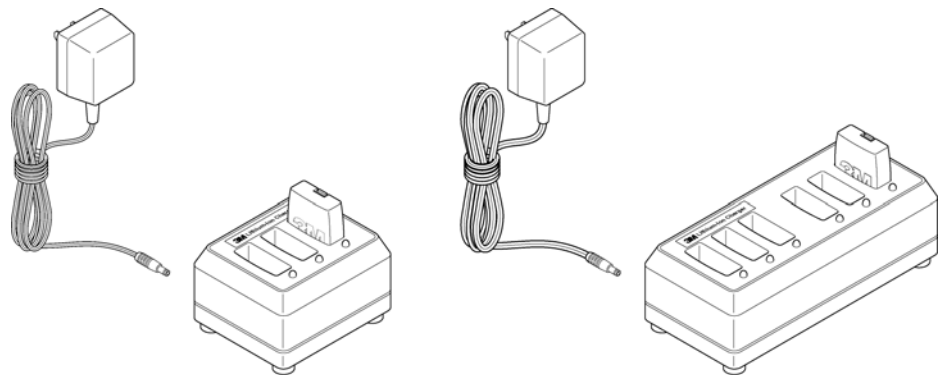

C1069-05A

Figure 4. 3-Slot and 6-Slot Battery Chargers

Base Station

The base station controls and indicators are shown below.

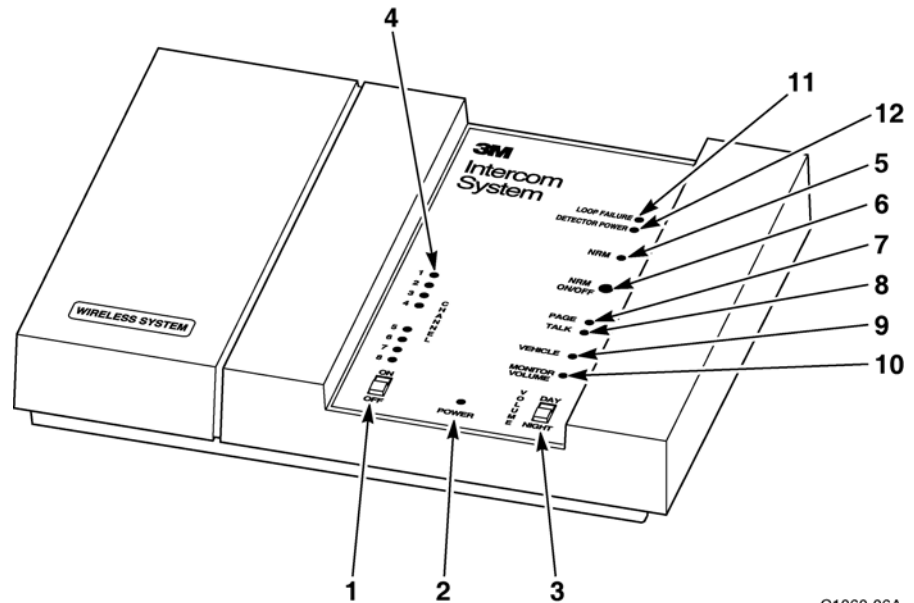

Figure 5. Base Station Controls and Indicators

C1060-06A

1 ON/OFF Switch

The ON/OFF switch controls power to the base station.

2 POWER Indicator

This indicator lights when the ON/OFF switch is in the ON position.

✓ Note

If for some reason the C1060 headset system does not operate and the system includes an optional wired backup system, turn off the C1060 Base Station to enable the backup system.

3 VOLUME DAY/NIGHT Switch

With the switch in the DAY position, the volume of the menu sign speaker is increased for daytime operation. With the switch in the NIGHT position, the volume of the menu sign speaker is decreased for nighttime operation. (Sound travels further and more efficiently at night.)

4 Channel Indicators

These indicators light to show which of the 8 channels is selected.

5 NRM Indicator

This indicator blinks when the Noise Reduction Module is switched on.

6 NRM On/Off Button

This button turns the optional Noise Reduction Module on or off.

7 Page Indicator

This indicator lights when headset Page communications occur.

8 Talk Indicator

This indicator lights when headset-to-menu sign “Talk” communications occur.

9 Vehicle Indicator

This indicator lights when a vehicle is detected at the menu sign.

10 Monitor Volume Access

This access hole allows for adjusting the volume of the optional monitor speaker.

11 Loop Failure

This indicator blinks if the optional vehicle detector or loop has failed.

12 Detector Power

This indicator lights if the optional vehicle detector is operating.

Headset

The headset controls are shown below.

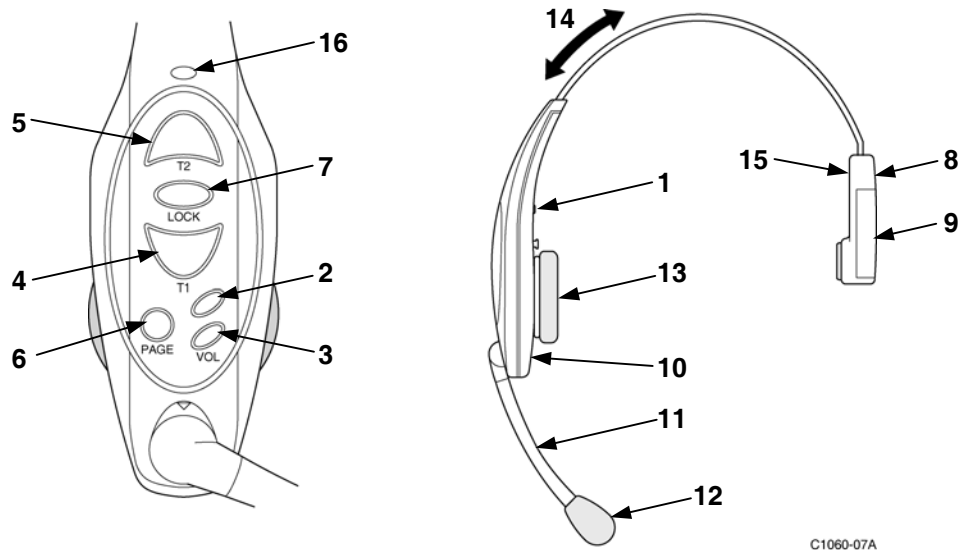

Figure 6. Headset Controls

1 ON / OFF Switch

Press the switch once to turn on the headset, and press it again (when the headset is on) to turn off the headset

2 Volume UP ▲ Control

Press the volume up ▲ control to increase the volume in the headset earpiece.

3 Volume DOWN ▼ Control

Press the volume down ▼ control to decrease the volume.

When either volume control is pressed, the headset emits a short tone to indicate the new volume level. There are multiple volume levels from minimum to maximum.

If the headset volume is at its maximum level, a low, continuous tone sounds when the volume up ▲ control is pressed. A low, continuous tone also occurs when the volume reaches minimum level and the volume down ▼ control is pressed.

When the headset is turned on, headset volume automatically returns to the mid-range level. Note that even when set to its lowest level, headset volume is not turned completely off.

4 T1 (Talk Lane 1) Switch

Press and hold the **T1 (Talk Lane 1)** switch to talk to the customer at the menu sign in lane 1. Release the switch to listen.

- 5 T2 (Talk Lane 2) Switch** For dual-lane systems, press and hold the **T2 (Talk Lane 2)** switch to talk to the customer at the menu sign in lane 2. Release the switch to listen.
For single-lane systems, T2 can also be used to talk to lane 1.
- 6 Page Switch** Press and hold the **Page** switch to talk to internal personnel without being heard by the customer at the menu sign. Release the switch to listen. (With the switch released, you can hear both menu sign customers and internal paging.)
- 7 Talk Lock Switch (Hands Free)** For duplex systems, press the talk lock switch once to talk and listen to the customer. This enables hands-free operation.
- 8 Battery Release** Push the battery release up and hold it there while removing the battery from the headset housing.
- 9 Battery** This rechargeable battery provides power to the headset.
- 10 Headset Programming Window** This window accepts the Infrared programming signals from the programming station to allow the headset to be programmed to the same channel as the base station.
- 11 Microphone** The microphone sends the headset operator's voice to the menu sign or other headset operators while eliminating unwanted background noise.
- 12 Windscreen** The replaceable windscreen optimizes the sound and protects the microphone.
- 13 Earphone/Earpad** The *earphone* is a speaker that broadcasts the voice from the customer at the menu sign or from other headset operators. The replaceable *earpad* covers the earphone and cushions the operator's ear to provide comfort. Earpad angle adjustment is required.
- 14 Headband Adjustment Slide** The headband adjustment slide is used to increase or decrease the size of the headband.
- 15 Battery Side** See Figure 12 for battery replacement. A 1/8-inch thick foam rubber pad cushions the side of the operator's head for comfort.
- 16 Indicator LED** Indicates operating status of the headset as follows:
– glows green when power is on
– glows red when in **Talk Lock** mode
– flashes to indicate successful programming

Battery Chargers

The 3-slot and 6-slot battery charger controls are shown below.

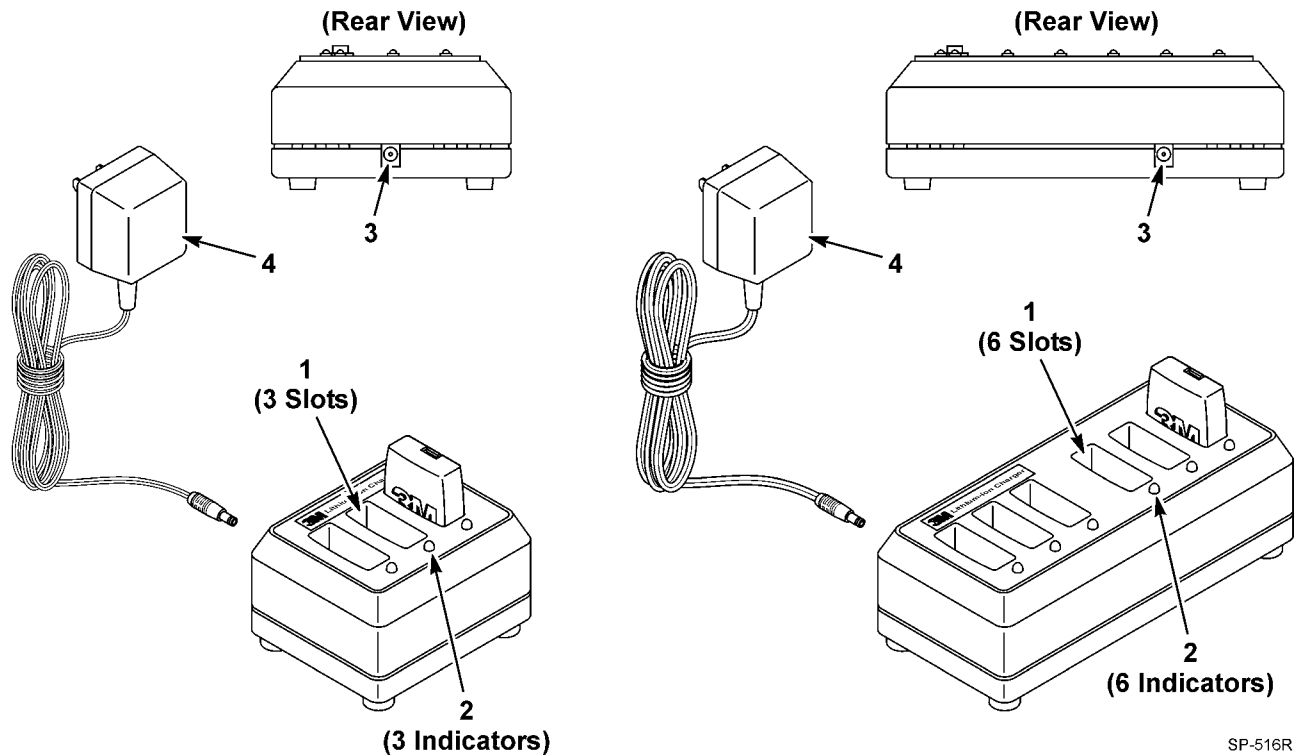

Figure 7. Battery Chargers

1 Charging Slots

The charging slots hold batteries during the recharging cycle.

2 Charging Status Indicators

The charging status indicators light RED or GREEN to indicate charging status:

RED indicates the battery is being charged.

GREEN to indicate the battery is fully charged.

3 Jack

This jack accepts the plug from the power supply cord.

4 Power Supply

The power supply provides power to the battery charger.

Headset Preparation

1. Rotate Ear Cup

Rotate ear cup and ear pad so that the indicator on the ear cup is aligned to the back of your head. This sets the angle of the ear pad for a comfortable fit.

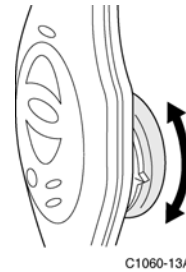

C1060-13A

Figure 8a

2. Adjusting Headband Size

Adjust the size of the headband until the ear pad rests against one ear and the battery-side pad rests just above the other ear.

- Slide the headband *out of the headset* to make it *larger*.
- Push the headband *into the headset* to make it *smaller*.

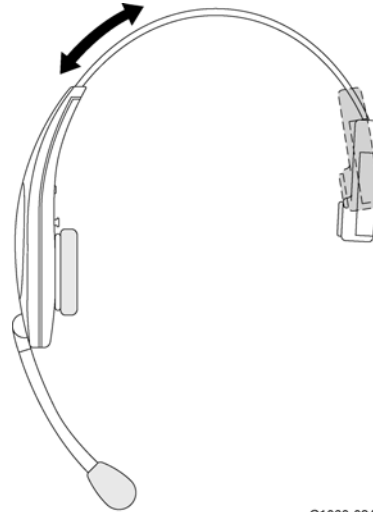

C1060-08A

Figure 8b. Headband Size

3. Positioning the Microphone

Rotate the microphone boom up or down so that its tip is in line with the corner of your mouth. Do not bend the rubber microphone boom. See Figure 9.



C1060-09A

Figure 9.

System Startup	System startup includes turning on the base station and each headset that will be used.
Turning On the Base Station	To turn on the base station: <ol style="list-style-type: none">1. Slide the power ON/OFF switch to the ON position. Check to see that the POWER indicator lights.2. Slide the VOLUME switch to the desired position (DAY or NIGHT).
Turning On the Headset	To turn on the headset, press the ON switch located on the inside of the transceiver housing. A single tone will sound in the earphone and the LED indicator will glow green to indicate the headset has been turned on.
Operating Modes	The system has several operating modes. The number of available operating modes depends on the system configuration (<i>single-lane vs dual-lane, standard communication vs duplex communication, etc.</i>).
Standby Mode	In the standby mode, the headset is on and waiting to receive communication from the menu sign or other headset operators. This mode is available with all system configurations.
Talk/Listen Mode	Use the talk/listen mode to talk to the customer at the menu sign. This mode is available with all system configurations.

Single-Lane Standard or Duplex Communication Systems

1. A *single beep* alert tone sounds in the headset at 2-second intervals when the system detects a customer (vehicle) at the menu sign.
2. When you hear the alert tone, press and hold T1 or T2 to talk to the customer at the menu sign. Release T1 or T2 to listen.

Dual-Lane Standard or Duplex Communication Systems

In dual-lane systems, some headsets are programmed to communicate with Lane 1 and others are programmed to communicate with Lane 2. The headsets are labeled accordingly.

1. An alert tone sounds in the headset when the system detects a customer (vehicle) at the menu sign:
 - The alert tone for Lane 1 is a single beep that repeats at 2-second intervals.
 - The alert tone for Lane 2 is a double beep that repeats at 2-second intervals.
2. When you hear the *single beep* alert tone, press and hold T1 and talk to the customer at menu sign 1. Release T1 to listen.

When you hear the *double beep* alert tone, press and hold T2 to talk to the customer at the menu sign 2. Release T2 to listen.

Cross-Lane Communication Systems

Communication During Peak Hours

During peak hours, the cross-lane module is turned *off* and the system functions like a dual-lane duplex system. Some headsets are programmed to communicate with Lane 1 and others are programmed to communicate with Lane 2. The headsets are labeled accordingly.

Communication During Off-Peak Hours

During off-peak hours, the cross-lane module is turned *on* to enable a single operator to communicate with customers in either lane (1 or 2).

1. An alert tone sounds in the headset when the system detects a customer (vehicle) at the menu sign:
 - The alert tone for Lane 1 is a single beep that repeats at 2-second intervals.
 - The alert tone for Lane 2 is a double beep that repeats at 2-second intervals.
2. When you hear the *single beep* alert tone, press and hold T1 and talk to the customer at menu sign 1. Release T1 to listen.

When you hear the *double beep* alert tone, press and hold T2 to talk to the customer at the menu sign 2. Release T2 to listen.

Talk Lock Mode (“Hands Free”)

Use this mode to operate “hands free.” The talk lock mode is only available with duplex system configurations.

In this mode, the headset automatically switches from standby to talk/listen when a customer is detected at the menu sign. The headset automatically switches back to standby when the customer leaves the menu sign.

✓ **Notes**

“Hands free” operation (talk lock mode) prevents all other headset operators from communicating.

“Hands Free” operation will not work in cross lane mode.

To use the talk lock mode, press the talk lock switch on the transceiver housing. To return to normal headset operation, press T1 or P.

The LED indicator changes from glowing green to glowing red when the headset is in the talk lock mode.

Page Mode

Use this mode to talk to other operators who are wearing headsets without being heard by the customer at the menu sign. This mode is available with all system configurations.

To page another operator, press and hold the page switch. Release the page switch to listen.

✓ Note

If you are **not** a menu sign operator, do not use the page mode while the menu sign operator is communicating. Doing so may interrupt or prevent communication between the menu sign operator and the customer.

Page Monitor Mode

Use this mode to listen for pages from other operators (without hearing the communication to and from the menu sign). This feature is convenient for managers and supervisors who only want to hear page communication. This mode is available with all system configurations.

To use the page monitor mode:

1. Turn the headset OFF. See Figure 10.

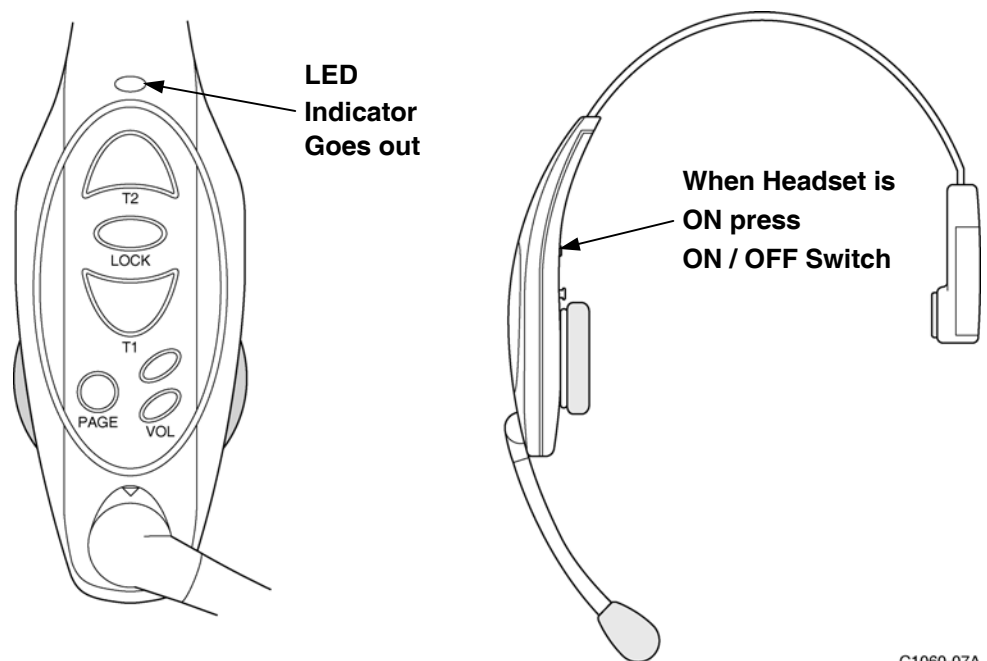

C1060-07A

Figure 10. Turning Headset OFF

2. While pressing and holding the page switch, turn the headset ON. This locks the headset in the page monitor mode. See Figure 11.

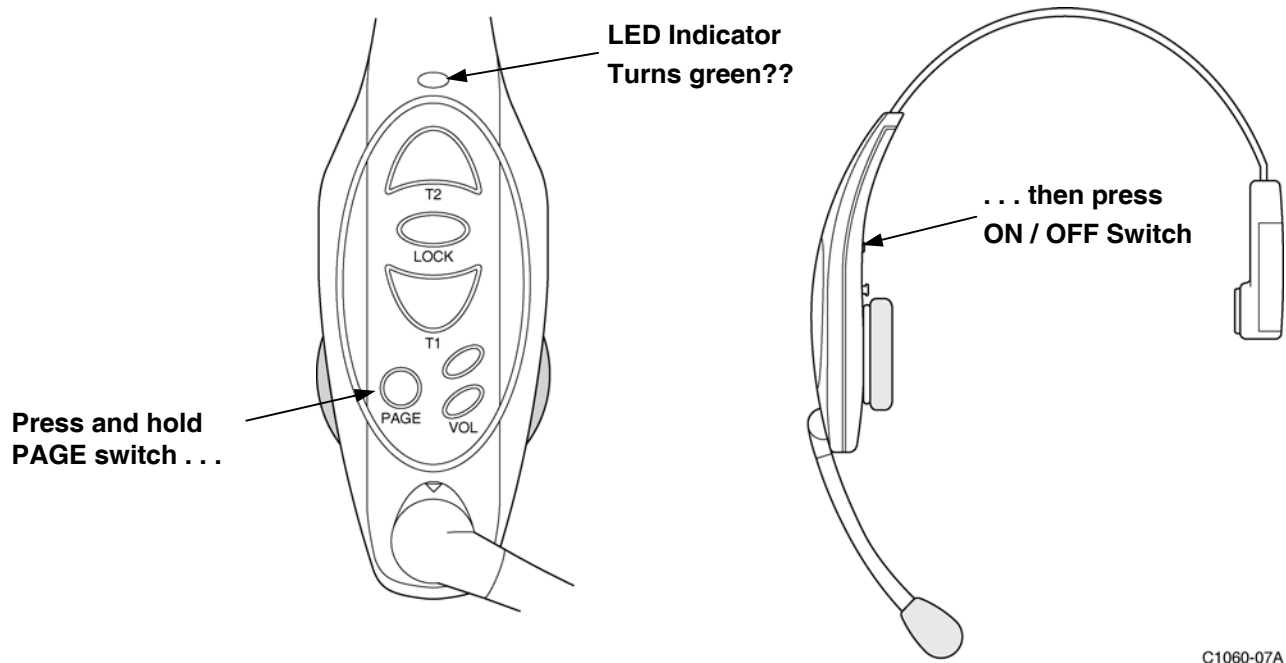

C1060-07A

Figure 11. Page Switch and On / OFF Switch

To respond to a page, press P (page switch).

To return to normal headset operation:

1. Turn the headset OFF.
2. Turn the headset ON.

Special Considerations

When using the talk/listen mode or the page mode, keep the following things in mind:

- Communication between the menu sign operator and the customer may be heard by several people.
- Only one headset operator can talk or page at a time.
- In the talk/listen mode, communication **to and from the headset** is heard by menu sign customers and all operators who are wearing headsets (except those in page monitor mode).
- In the page mode, communication **from any headset** is heard only by all operators who are wearing headsets (not the customer at the menu sign).

Headset

Replacing the Battery

When the battery voltage is too low, the headset sounds a short, low-volume tone at seven-second intervals to alert the operator to install a fully charged battery. The “low battery tone” continues for two minutes after which the headset turns off automatically to prevent damage to the batteries.

✓ Note

When installing a battery, make sure it is fully charged. It is important to remember that an *unused* C1060 battery loses five percent of its charge per week. If a battery has not been used for several weeks, make sure to charge prior to use.

To replace the battery:

1. Slide and hold the battery release. See Figure 12.
2. Remove the discharged battery from the battery housing.
3. Insert a **fully charged battery** in the housing with the notch facing the battery release. Make sure the battery is fully inserted (battery release clicks). See Figure 12.

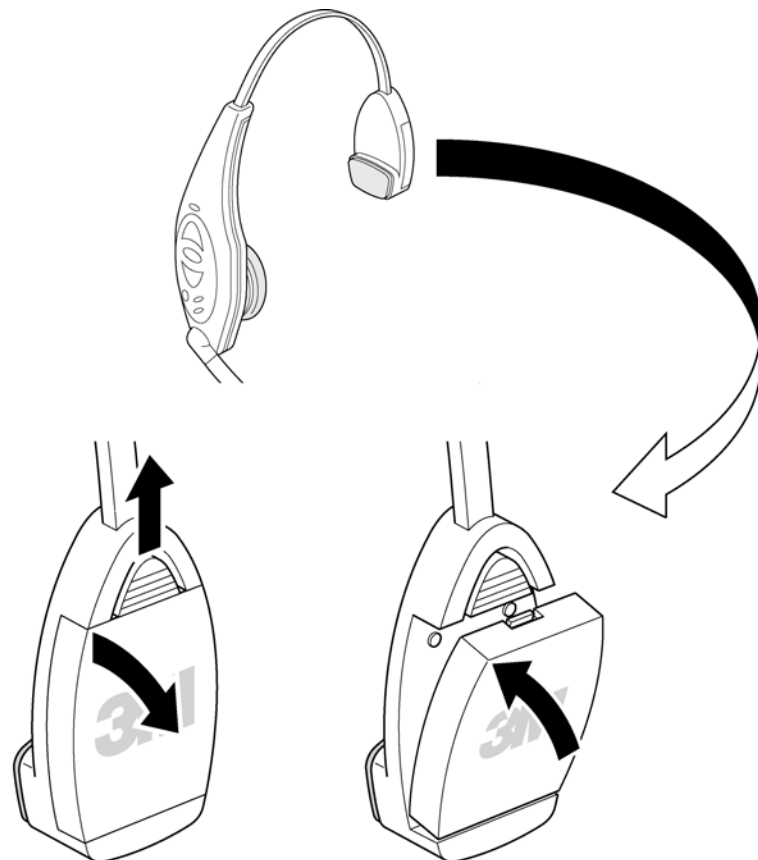
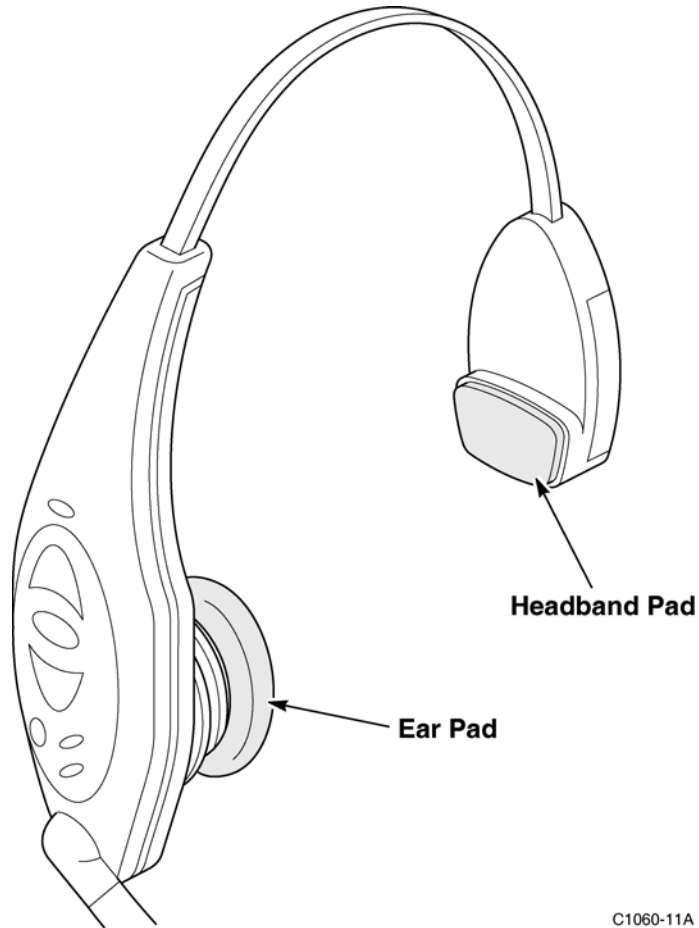

Figure 12.

C1060-10A

Replacing the Ear and Headband Pads

To replace the ear pad, remove the worn/damaged ear pad from the ear cup and replace it with a new pad. See Figure 13.



C1060-11A

Figure 13.

To replace the headband pad, remove the worn/damaged pad by peeling it from the back of the battery housing. Remove protective backing from new pad and press it into place on the back of the battery housing. See Figure 13.

Battery Charger

Location

The battery charger should be placed on a flat surface such as a desktop or table in a clean, dry environment.

Cleaning the Contacts

If the indicators fail to light during charger operation, clean the contacts using a water-moistened cotton swab.

Batteries

Care, Handling and Storage

Avoid dropping batteries.

Do not carry batteries in your pockets or leave them in hot, damp or dirty places.

Clean the battery contacts periodically using a water-moistened swab.

Be careful not to short the battery contacts together.

Do not set the batteries contact-side down on a bare metal countertop.

Low Battery Tone

When the battery voltage becomes too low, a short, low-volume tone sounds in the headset at seven-second intervals to alert the operator to replace with a fully charged battery.

The “battery voltage low tone” continues for two minutes after which the headset turns off automatically to prevent damage to the batteries.

Charging Batteries

To charge a battery, insert the battery in one of the charging slots as shown in Figure 14.

- The indicator lights RED to indicate the battery is charging.
- The indicator lights GREEN to indicate the battery is charged.

✓ Note

Discharged batteries require 1-1/2 to 2 hours to charge.

✓ Note

When the GREEN indicator lights, the battery is approximately 80% charged. An additional 1/2 hour of charging is required to achieve maximum charge.

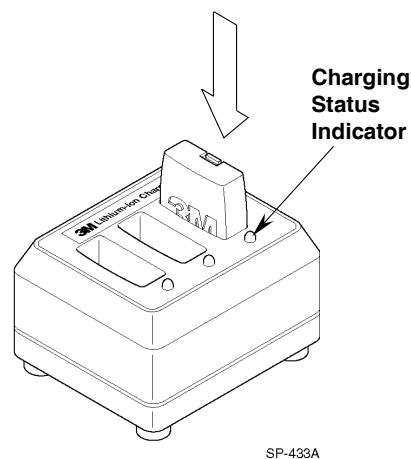

Figure 14.

Disposing of Batteries

To help protect the environment, C1060 rechargeable batteries and other components: Dispose of batteries, power supplies, battery charger and base station in accordance with federal, state & local requirements. If preferred, return these components to 3M Service Center for disposal.

Making Sure Batteries are Ready for Use

Follow these tips to make sure batteries are always ready for use:

- Have an extra battery for each headset. This helps ensure that a fully charged battery is always available.
- Recharge a low battery as soon as it is removed from the headset. When a battery is low, repeat tones are heard in the headset.
- Keep the battery contacts clean: both those on the battery and those in the headset battery holder. To clean the contacts, use a water-moistened cotton swab.
- Remember that a battery recharge takes approximately 1-1/2 to 2 hours.
- Avoid removing and reinserting batteries while they are charging (charging status indicator is RED).
- Remember that batteries discharge fastest during Talk and Page operation. Avoid unnecessary communications.

Important Information about C1060 Rechargeable Batteries

Keep the following information in mind as you operate the system and as you establish operating procedures:

- Each 3M battery contains an internal protective device to prevent unsafe discharge rates. But, as with any battery, avoid shorting across the battery contacts with metal items. Never carry a battery in a pocket or place it in a drawer where it can accidentally be shorted by keys, coins etc.
- Have adequate charging capacity for the number of headsets in your system. One 3-slot battery charger will handle up to three headsets. Use of more than three headsets requires a 6-slot battery charger.
- Batteries perform best at moderate temperatures. Extremes of heat and cold reduce their performance.
- An unused C1060 battery loses five percent of its charge per week. Batteries that have not been used for several weeks should be recharged before use.

 **Warning**

Do not open battery, or expose it to heat above 200° F.

Programming the Headset for Cross-Lane Operation

The headsets are factory programmed for single-lane operation to enable the operator to press either T1 or T2 to communicate with lane 1.

For cross-lane systems, the headsets must also be programmed to enable communication with either lane 1 *or* lane 2. With the cross-lane module turned ON, the lane 1 **or** lane 2 operators can press T1 to talk to lane 1 customers **or** T2 to talk to lane 2 customers.

To program the headset for cross-lane operation:

- While pressing and holding *both* the T1 and T2 switches on the headset, turn the headset ON. Hold all three switches for at least 5 seconds. See Figure 15.
- Audible tones will be heard in the headset earpiece, indicating that the headset is programmed for cross-lane operation.

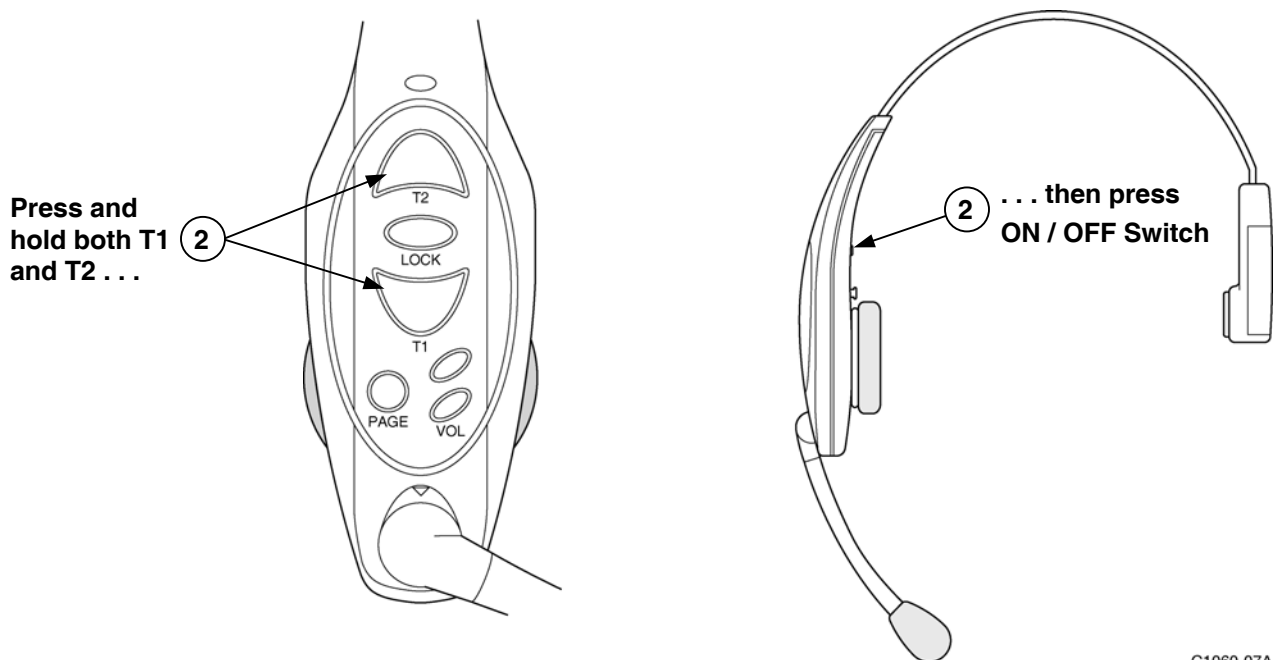

C1060-07A

Figure 15.

Reprogramming

To remove this function and lock T1 and T2 back together, first turn the headset OFF, then hold down either T1 or T2 while pressing ON for 5 seconds. You will hear an acknowledging beep. (Holding down T1 configures the headset to be a lane 1 headset; holding down T2 configures it for lane 2.)

Enabling/Disabling the Talk Lock Feature

The talk lock feature provides hands free operation in duplex communication systems. With the talk lock feature enabled, the headset automatically switches from standby to talk/listen when a customer is detected at the menu sign. The headset automatically switches back to standby when the customer leaves the menu sign.

To enable or disable the talk lock feature:

1. Turn the headset OFF.
2. Press and hold the TALK LOCK button while pressing and holding the ON button until audible tones are heard. This indicates that the feature has been enabled or disabled.
3. Check headset operation to determine if the talk lock feature has been *disabled or enabled*. With the talk lock feature **enabled**:
 - The headset automatically switches from standby to talk/listen when a customer is detected at the menu sign.
 - The headset automatically switches back to standby when the customer leaves the menu sign.

✓ **Note**

The headsets are shipped with the talk lock feature enabled.

Changing Channels if Interference is Encountered

Symptoms of Radio Frequency Interference:

- The operating range between the base station and the headsets gets very short, sometimes 25 feet or less.
- Normally, you will hear nothing to indicate interference. Occasionally, you might hear a whistle or a chirp in the background, but seldom, if ever, will you hear talking.
- The Talk or Page LED on the base station flickers briefly causing one of the following:
 - a. The system may leave the STANDBY mode, and go into the LISTEN mode with no vehicle alert heard.
 - b. The system may drop out of TALK LOCK by itself.

Solutions:

- Change the base station to another channel, at least three channels away. For single lane systems, a better solution is to change jumper J3 to Lane 2.
- Locate and shut off other 900 MHz devices in the building, such as cordless phones, video systems, and speaker systems.
- In cases where a cellular phone tower is nearby, certain combinations of cell frequencies may cause random interference. In some cases, changing channels may have no effect. Please call your local 3M Dealer, or 3M F.S.T. Communications Products Technical Service (800-328-0033) in these cases.

The C1060 system is capable of operating on any one of eight different channels. You can correct these types of interference by changing the base station operating channel. To do this:

1. With the base station turned on, press and release the Channel Select switch once. (This advances the system to the next channel.) One of the red indicators (1–8) will light, indicating the newly selected channel. See Figure 16.

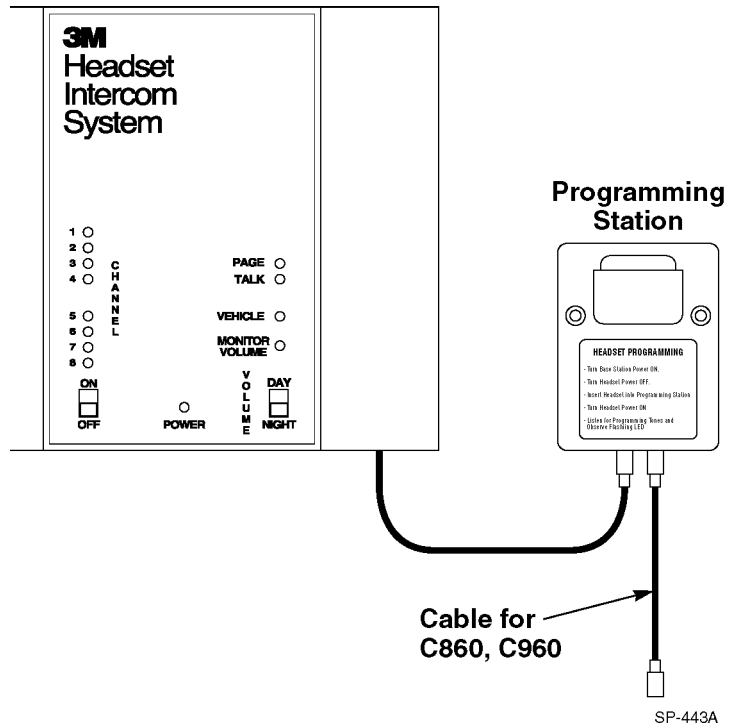

Figure 16.

2. Pull outward on the right side of the base station half-cover and then lift and remove the cover. See Figure 17.

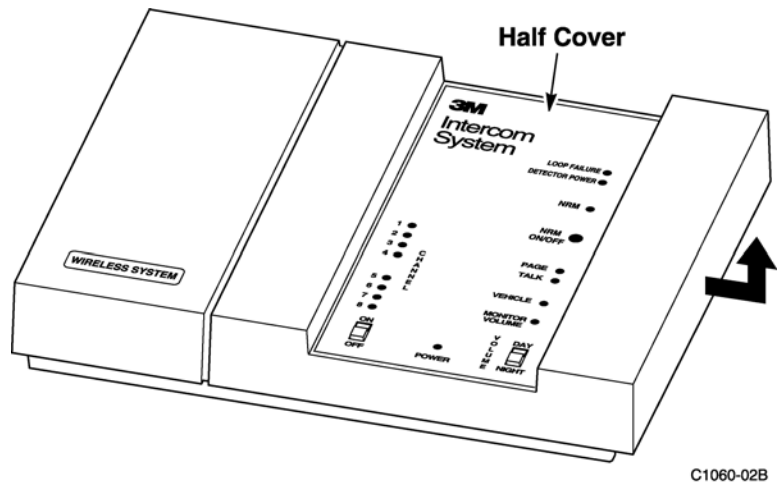

Figure 17.

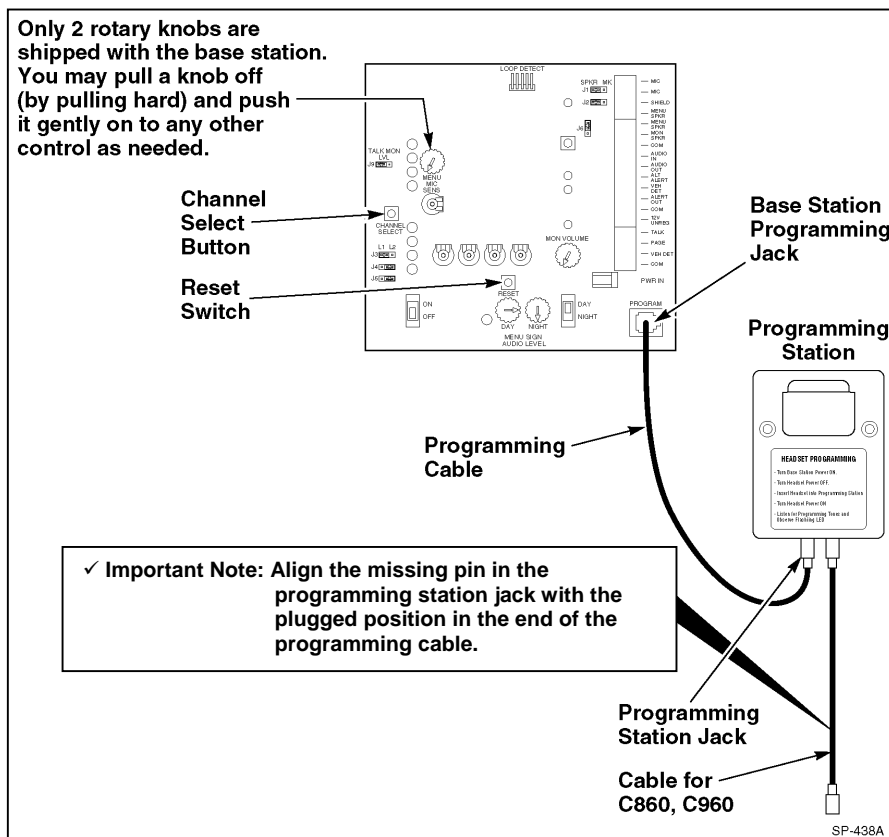
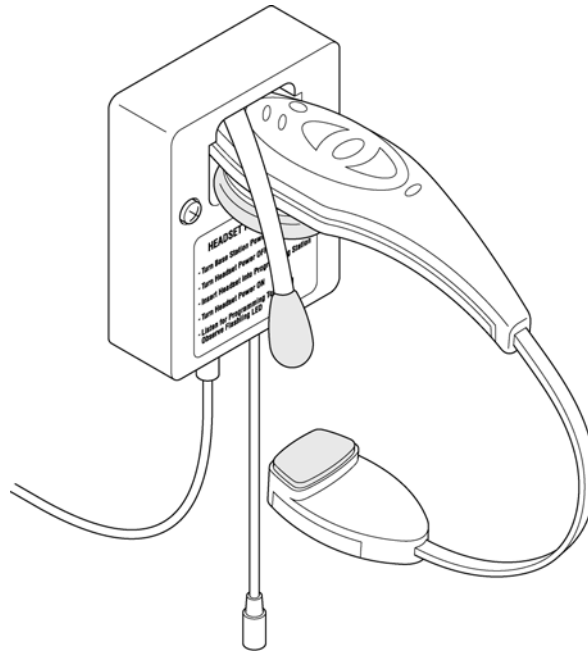

Figure 18.

3. Press the RESET switch to “read” the new channel selection into the microprocessor.

✓ Note

When two systems are used in a cross-lane application, both base stations **must** be set to the same channel.



C1060-12A

Figure 19.

4. With the headset turned OFF, swing the microphone back, and insert the headset into the programming station with its programming window facing toward the programming cable jacks. See Figure 19.
5. Turn the headset ON. The indicator LED flashes, indicating that programming is complete.
6. Repeat Steps 1 through 5 to program the rest of the headsets.

The headset is now programmed to the same channel as the base station. If interference continues to occur, repeat the channel programming procedure. After seven channel changes, the original channel will again be encountered. If none of the 8 channels are interference-free, try 8 additional channels on lane 2 by following the steps below: **Note: These steps may be used for single-lane systems only.**

1. On the base station, move jumper J3 to LANE 2.
2. Press the RESET button, or turn the base station OFF, then back ON.
3. Program all headsets at the programming station by repeating the steps listed previously in “**Changing Channels if Interference is Encountered.**”

Changing the Day/Night Switch Setting

Outdoors, sound travels best at night when air temperatures are cooler and background noise is reduced. To allow you to reduce the volume of the menu sign speaker to a lower, pre-set nighttime level, the base station has a VOLUME DAY/NIGHT switch. See Figure 20.

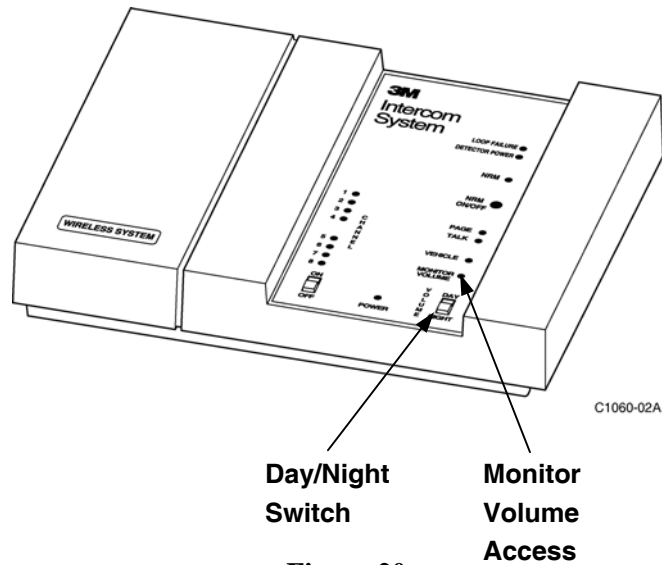

**Day/Night
Switch** **Monitor
Volume
Access**

Figure 20.

Normally, the VOLUME DAY/NIGHT switch is always left in the DAY position.

However, if local ordinances require quieter nighttime operation of the menu sign, move the VOLUME DAY/NIGHT switch to the NIGHT position.

If the system has an optional monitor speaker, adjust its volume using the following procedure:

1. With the base station turned ON, insert a small straight-blade screwdriver into the MONITOR VOLUME access hole. See Figure 20.
2. Turn the volume control clockwise to increase the volume or counterclockwise to decrease it.

Adjusting the Monitor Speaker Volume

Introduction

To use the following troubleshooting guide, locate the problem in the left column and look for the problem's possible causes and corrections in the middle and right columns. Possible causes are listed in the order in which they are most likely to happen. Check for possible causes in the given sequence to help isolate the problem.

System Troubleshooting

Problem	Possible Cause	Solution
1. No communications. All headsets hear static.	<ol style="list-style-type: none"> 1. The base station is not ON. 2. Base station and headsets are not programmed to same channel. 3. The Base Station is defective. 	<ol style="list-style-type: none"> 1. Turn the base station ON. Make sure the power transformer is plugged into the wall outlet <u>and</u> into the base station power receptacle. If the red power light does not come on, check for power at the wall outlet. 2. Reprogram the headsets with the programming cable. 3. Call for authorized service.
2. A single headset hears static.	<ol style="list-style-type: none"> 1. Headset is not programmed to same channel as base station. 2. Defective programming station. 3. Defective headset. 	<ol style="list-style-type: none"> 1. Reprogram the headset with the programming station. 2. Try to program other headsets. If they won't program, replace the programming station. 3. If the other headsets program OK, the single headset needs repair.
3. A single headset is dead. No static is heard.	<ol style="list-style-type: none"> 1. The headset is not turned on. 2. The battery is discharged. 3. The headset is defective. 	<ol style="list-style-type: none"> 1. Press the ON button. 2. Replace the battery with a fully charged one. 3. Call for authorized service.
4. No vehicle alert tone in headset.	<ol style="list-style-type: none"> 1. No power to the vehicle detector. 2. Vehicle detector is "locked up." 3. The base station alert tone volume is set too low. 	<ol style="list-style-type: none"> 1. Plug the vehicle detector into power outlet or replace the detector fuse. 2. Remove power to vehicle detector for a few seconds to reset the detector. 3. Adjust alert tone volume.

<p>5. All headsets will not go into Standby (silence) when the vehicle leaves the menu sign.</p>	<ol style="list-style-type: none"> 1. This is normal when a pulse (air switch) type of vehicle detector is used. 2. There is a large metal object near the loop in the driveway (if a loop is used). 3. The Loop detector is “locked up.” 4. Defective vehicle detector. 	<ol style="list-style-type: none"> 1. Press the Page switch to silence the menu microphone. 2. Remove the object. 3. Unplug the loop detector from the AC outlet and plug it back in to reset the detector. 4. Call for authorized service.
<p>6. Audio on all headsets cuts out or is interrupted.</p>	<ol style="list-style-type: none"> 1. The cause could be radio interference. These are symptoms of interference: <ul style="list-style-type: none"> • The operating range between the base station and the headsets gets very short, sometimes 25 feet or less. Normally you will hear nothing to indicate interference. • The Talk or Page light flickers briefly causing the system to leave standby mode, and go into listen mode with no vehicle alert heard. • The system may drop out of Talk Lock by itself. • When pressing the Channel Select button on the Base Station, the channel lights move sluggishly or not at all. 2. Loose or frayed wiring. 3. Poor location of Base Station (behind large metal objects, too far from work area, etc.). 	<ol style="list-style-type: none"> 1. Change the channel on the base station to one at least three channels away. <ul style="list-style-type: none"> • If using a single base station, move jumper J3 to the lane 2 position. This provides 8 additional channels from which to choose. • Locate and shut off other 900 MHz devices in the building, such as cordless phones, video and speaker systems, and video monitors. 2. Call for authorized service. 3. Relocate the Base Station, or add an additional Base Station to extend the range of the system.

<p>7. No Talk or listen from the menu sign when using the backup wired intercom. The C1060 system works OK.</p>	<ol style="list-style-type: none"> 1. The base station is turned on. 2. No power to the backup intercom. 3. The volume controls are set too low on the backup intercom. 4. Defective backup intercom or wiring. 	<ol style="list-style-type: none"> 1. Turn the base station OFF. 2. Turn the backup intercom on or plug in its power transformer. 3. Turn the volume controls up. 4. Call for authorized service.
<p>8. No Talk or Page to other headsets from a single headset, or Talk or Page buttons require excessive pressure to operate.</p>	<ol style="list-style-type: none"> 1. Worn or defective Talk or Page switch. 2. Defective headset. 	<ol style="list-style-type: none"> 1. Call for authorized service. 2. Call for authorized service.
<p>9. Low Talk volume on a single headset.</p>	<ol style="list-style-type: none"> 1. The holes in front of the microphone are plugged with dirt or grease. 2. Operator is not positioning the microphone correctly. 3. Defective headset. 	<ol style="list-style-type: none"> 1. Call for authorized service. 2. Refer to Operating Guide. 3. Call for authorized service.
<p>10. Louder Talk volume or feedback from a single headset.</p>	<ol style="list-style-type: none"> 1. The holes in back of the microphone are plugged with dirt or grease. 	<ol style="list-style-type: none"> 1. Call for authorized service.
<p>11. Constant programming tones heard on a single headset. Programming cable has no effect.</p>	<ol style="list-style-type: none"> 1. Defective headset. 	<ol style="list-style-type: none"> 1. Call for authorized service.
<p>12. The “hands free” function does not work.</p>	<ol style="list-style-type: none"> 1. The Talk Lock button is not enabled on the headset. 2. The system is operating in Standard mode. 	<ol style="list-style-type: none"> 1. Refer to the Operating Instructions to enable Talk Lock. 2. Talk Lock is disabled in Standard mode.

Battery and Battery Charger Troubleshooting

Problem	Possible Cause	Solution
1. No lights come on when a battery is inserted into charger.	1. Dirty contacts on battery or charger. 2. No power to charger. 3. Defective battery. 4. Defective charger.	1. Clean contacts on battery and charger with a water moistened swab. 2. Make sure power transformer is plugged into charger and a “live” outlet. 3. Try a known good battery. 4. Call for authorized service.
2. Short battery life.	1. Worn out batteries. 2. Wrong type of power transformer used for charger.	1. Replace battery. 2. Make sure power transformer is marked “Secondary Voltage 14 VAC.”
3. The green light on the charger never comes on.	1. Defective battery.	1. Replace the battery.

Service

For communications equipment sales and service, contact your local 3M authorized intercom dealer. If special service assistance is needed, or for information on how to properly dispose of your non-functional C1060 rechargeable batteries, please call (800) 328-0033. For more information, visit the 3M Foodservice Web site: <http://www.3m.com/foodservice>

Warning

Always replace batteries, battery chargers and power supplies with 3M approved units acceptable for use in this system to avoid system function & safety concerns



Commercial Care Division
Food Services Trade Department
3M Center
St. Paul, MN 55144-1000

Printed in U.S.A.
©3M 2006
70-0710-3648-0 Rev. B